



home solar set

New Power Energy AG
np-energy.com



WELCOME TO THE FUTURE OF PRIVATE SOLAR ENERGY.

Welcome to the **np home solar set** by **New Power Energy** – the simplest solution for environmentally friendly solar energy in the private sector for home use.

The **np home solar set** makes a personal investment into green energy future plug and play child's play: Simply set it up outdoors, plug it into a socket - and instantly use sustainable and inexpensive energy in your own four walls.



newpower

New Power Energy AG

Brünigstraße 114

CH-6060 Sarne

T +41 41 508 7070

office@np-energy.com

np-energy.com

WELCOME

WILLKOMMEN IN DER ZUKUNFT PRIVATER SOLARENERGIE

Willkommen bei **np home solar set** von **New Power Energy** –
der einfachsten Lösung für umweltfreundliche Solarenergie
im privaten Bereich.

Das **np home solar set** macht die persönliche Investition
in eine grüne Energiezukunft zum Plug and Play-Kinderspiel:
Einfach im Freien aufstellen, an eine Steckdose anstecken –
und sofort nachhaltige und kostengünstige Energie in den
eigenen vier Wänden nutzen.



home solar set





CONTENT



CONTENT

The Components	7
Montage	9-19
Positioning	13
Connect panels to inverter	14
Features of the NP Exclusive Plug	21
App NP home	23
Important Information (EN, DE)	25-27
How it works	29
Features	30







PRODUCT PARTS



THE COMPONENTS

- 2 NPE panels
- 2 Small Legs
- 2 Big Legs
- 2 Ballast Trays
- 1 Box with Construction Parts
- 1 NPE WVC 600 Inverter
- 1 NP socket
- 1 Mounting Angle
- 1 Grid cable
- 16 Rubber Feet
- 1 Construction Manual

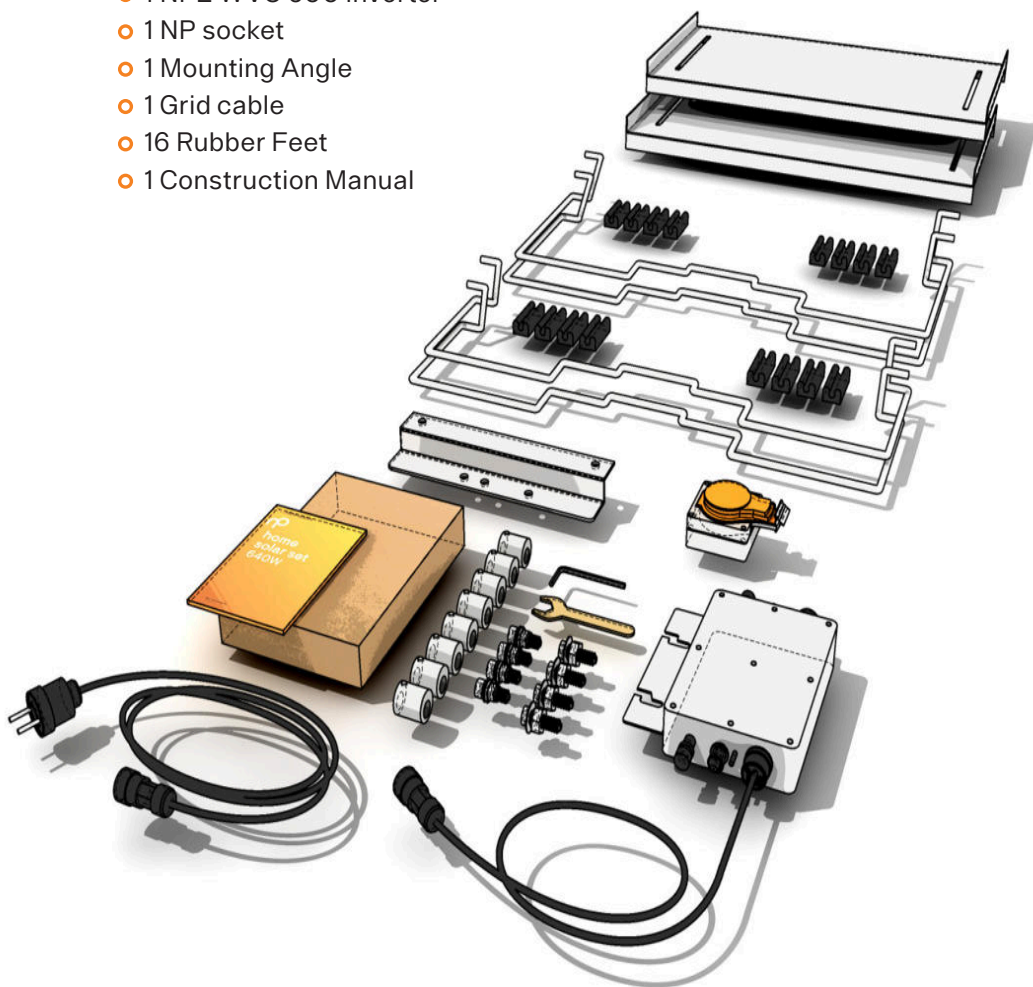





MONTAGE



1 LEG MOUNTING

Position the 16 rubber feet (4 for each leg)
Fix the legs with the AI-nuts

2x

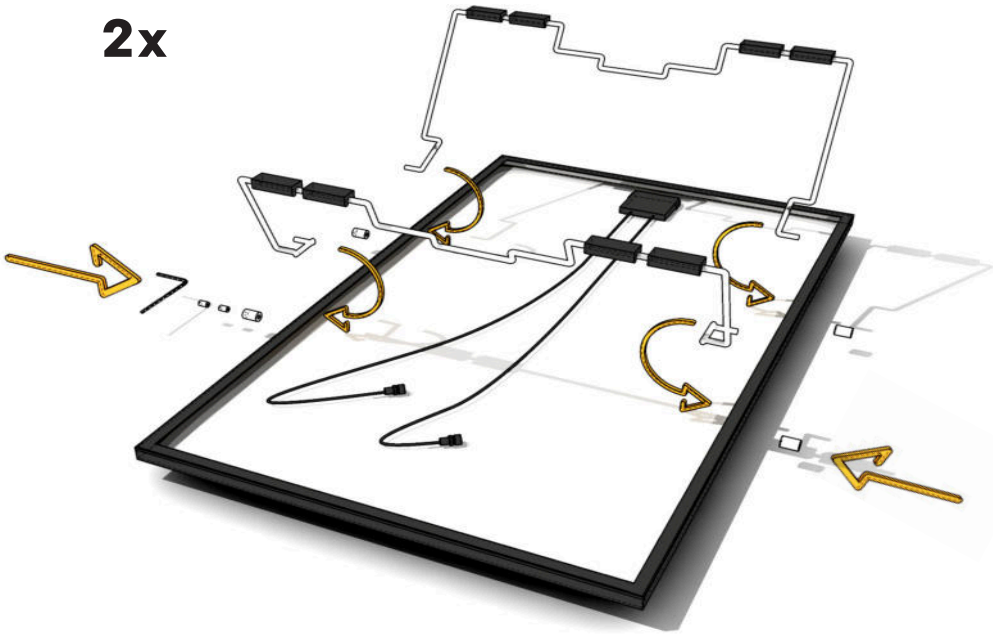



2 INVERTER A MOUNTING

Fix the Inverter support angle with two M8 Screws to one module frame

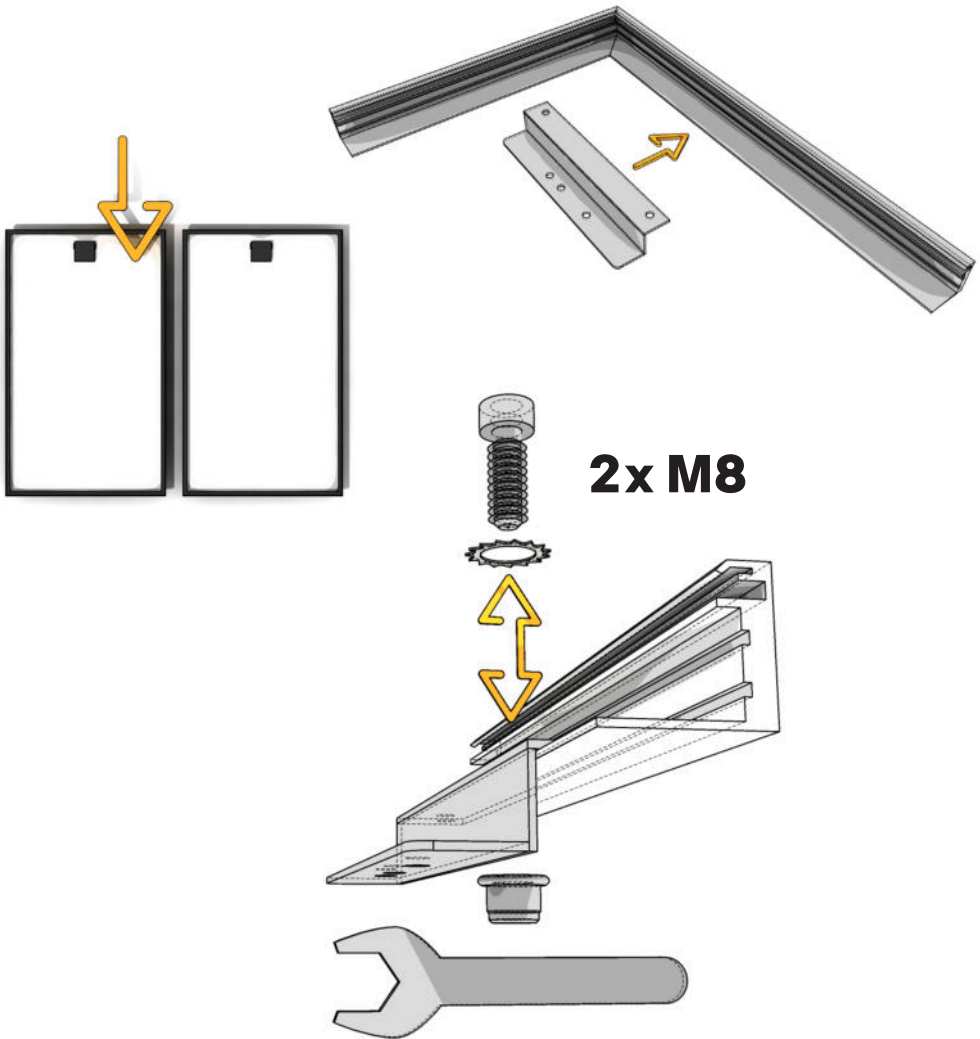



MONTAGE



2 INVERTER B MOUNTING

Fix the Inverter Bracket with two M8 Screws to the Inverter Support Angle

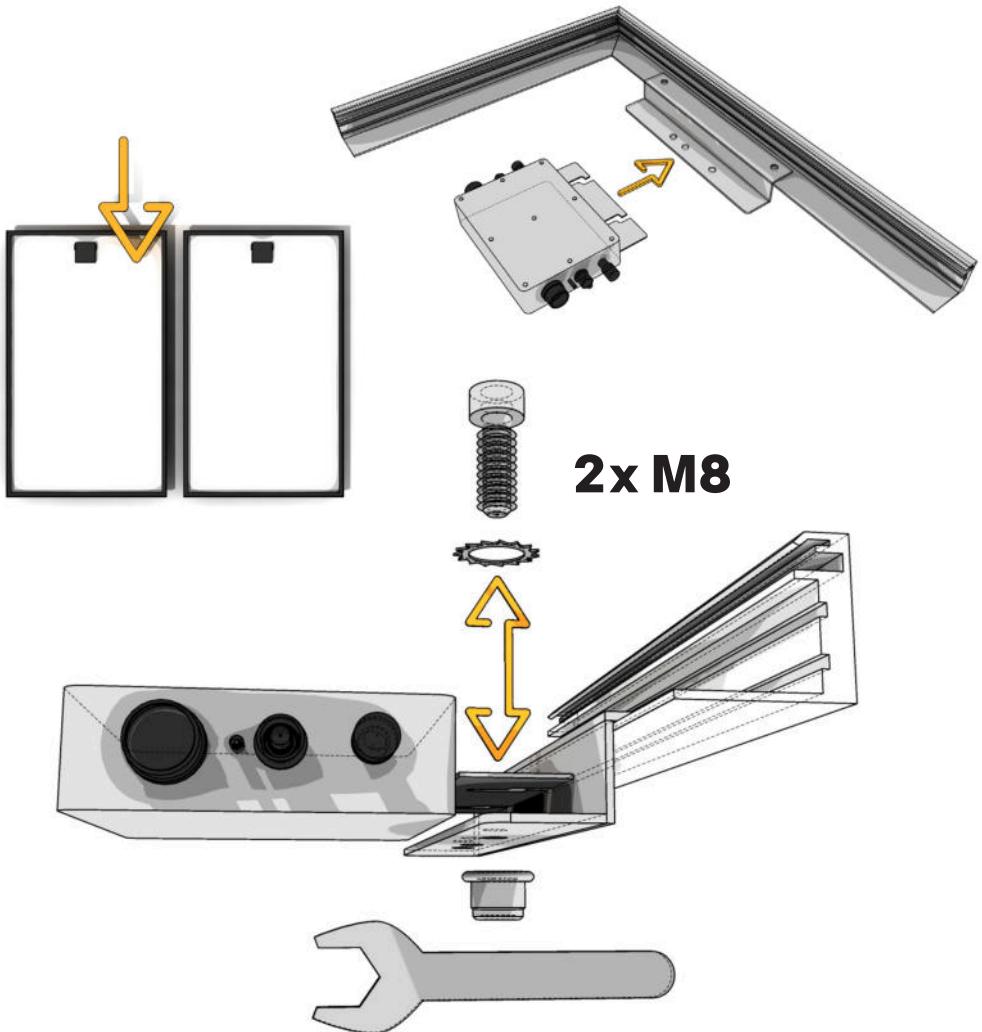





POSITIONING



3 POSITIONING OF THE TWO MODULES

1.



2.



3.





4 CONNECT THE A TWO PANELS TO THE INVERTER

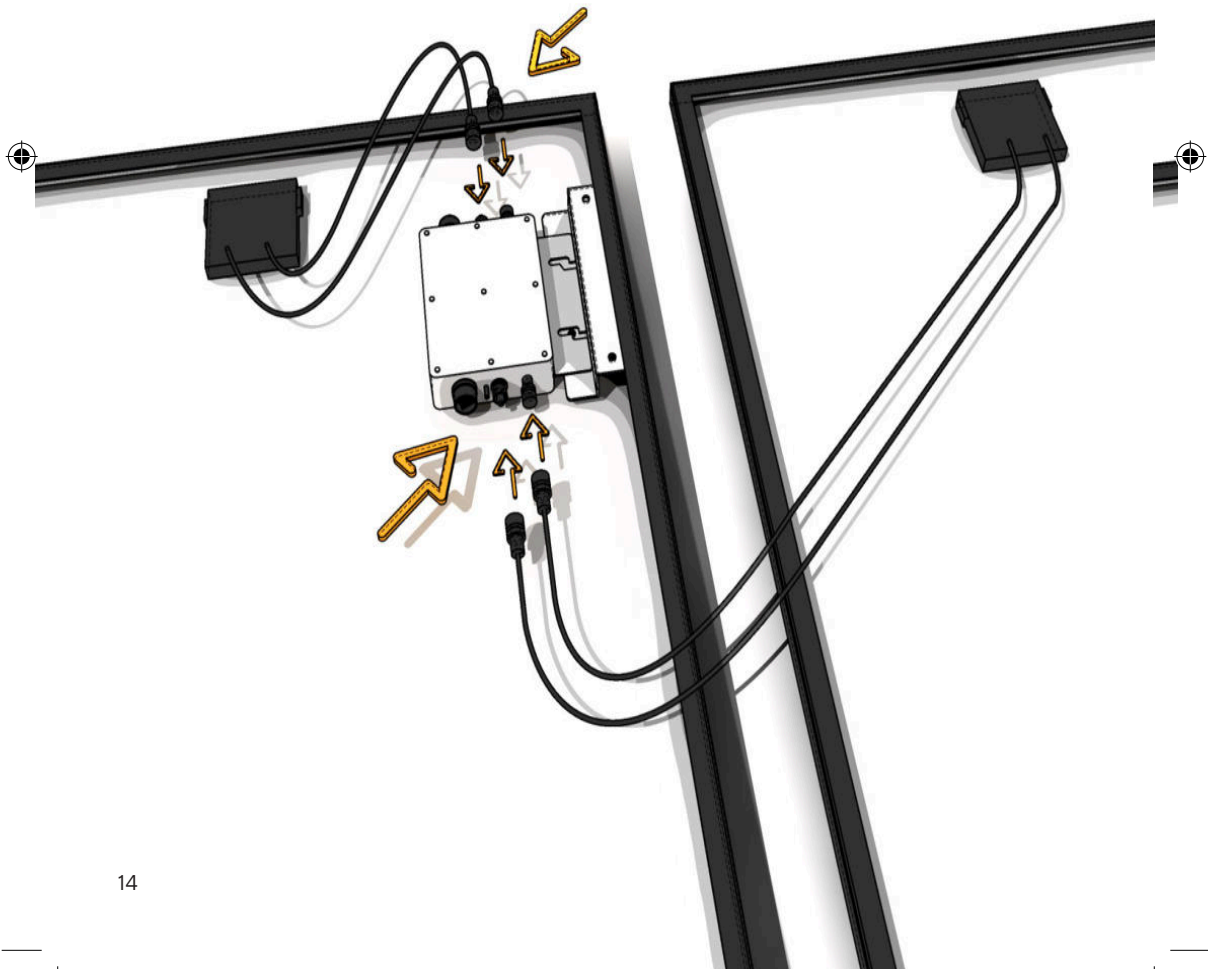



MONTAGE



4 B CONNECT THE AC POWER CABLE TO THE INVERTER

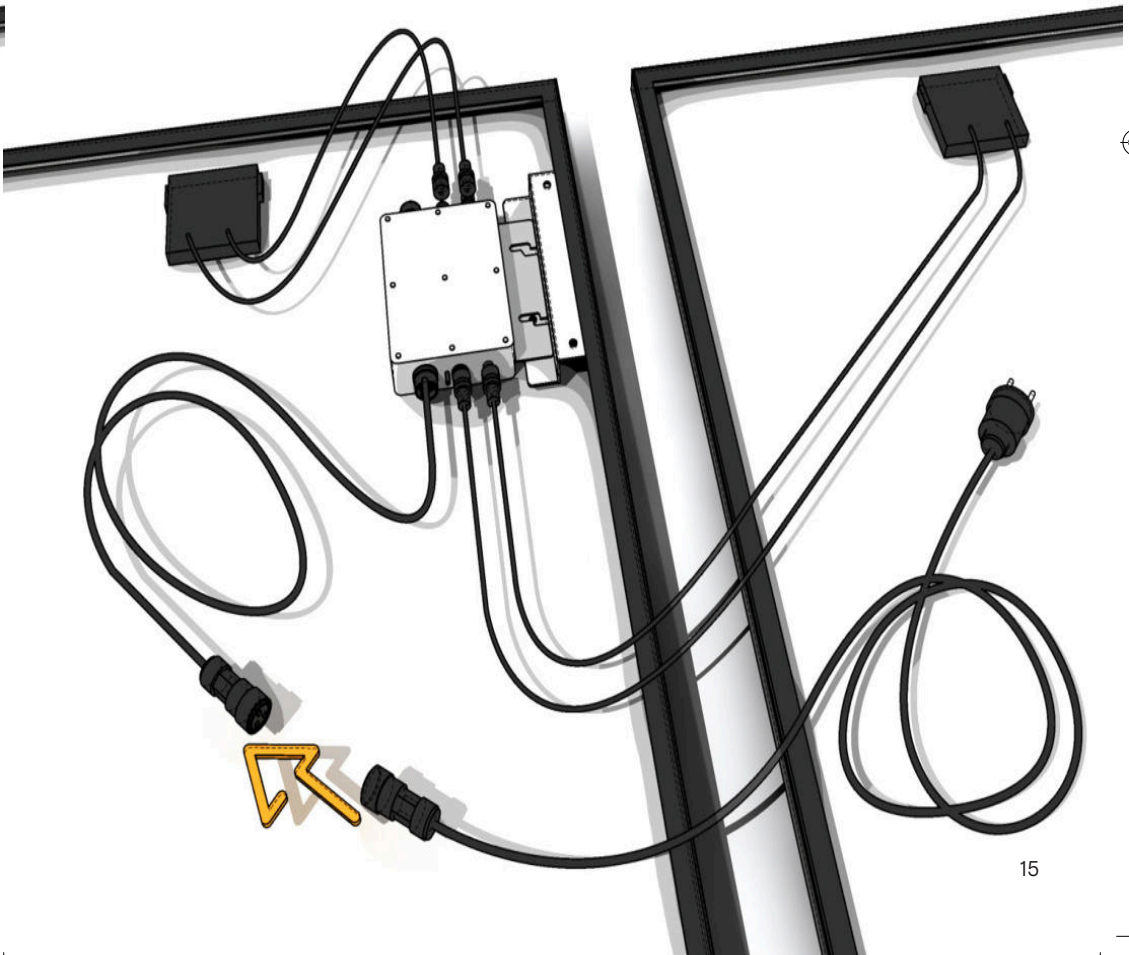

15





5 CONNECTION OF A THE PV MODULES

Position 2 modules side by side and screw together the Al-Nuts

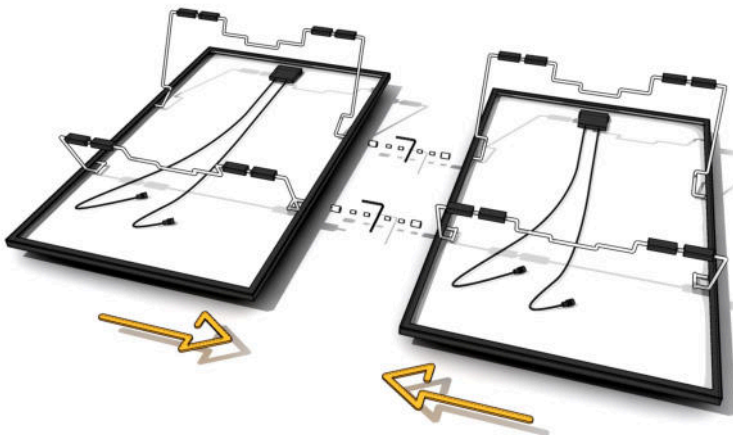



MONTAGE



5 ORIENTATION OF B THE PV MODULES

Position the modules to optimize the yield

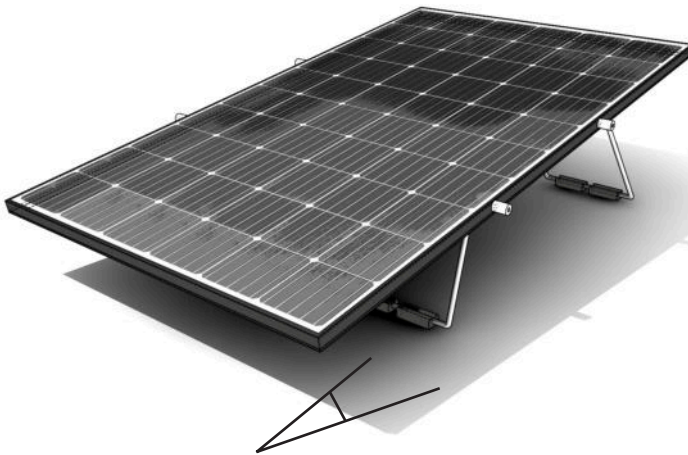

Inclination 20°

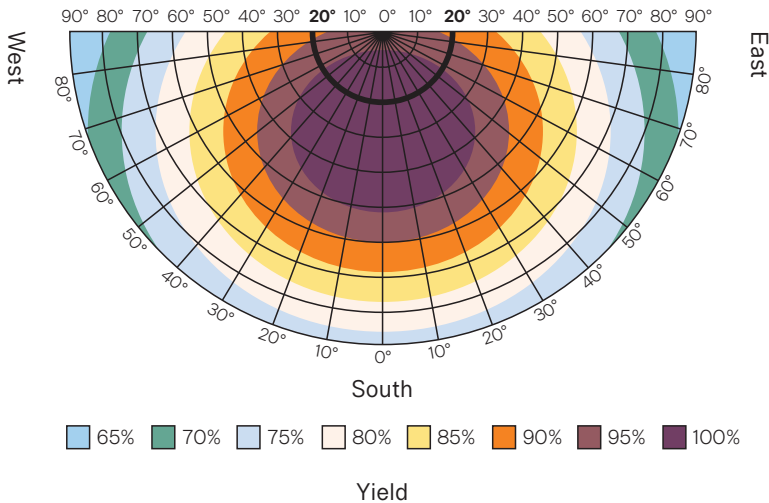





MONTAGE



6 PUT BALLAST ON THE TRAY AND ON THE BACK LAY



Before plugging please read the „important Information“

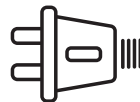
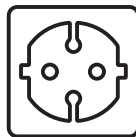



Connect up to 5 home solar sets:

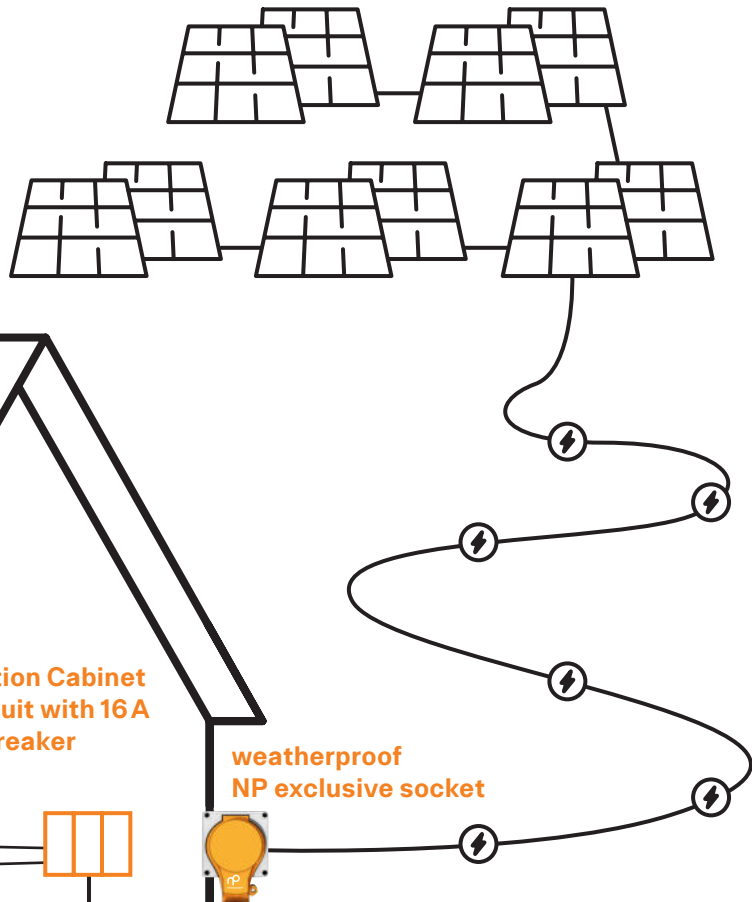

Distribution Cabinet
New circuit with 16A
circuit breaker

weatherproof
NP exclusive socket





7 FEATURES OF THE NP EXCLUSIVE PLUG

- ✓ Weatherproof
- ✓ Lockable

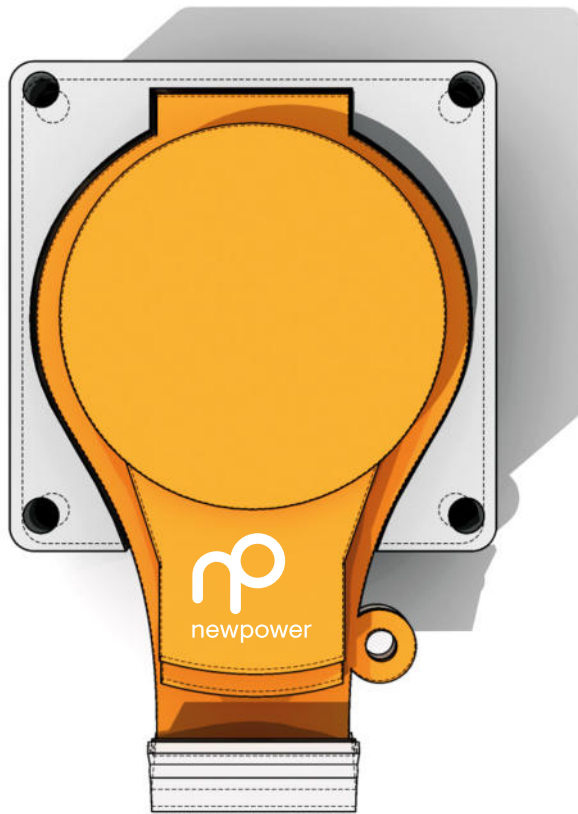

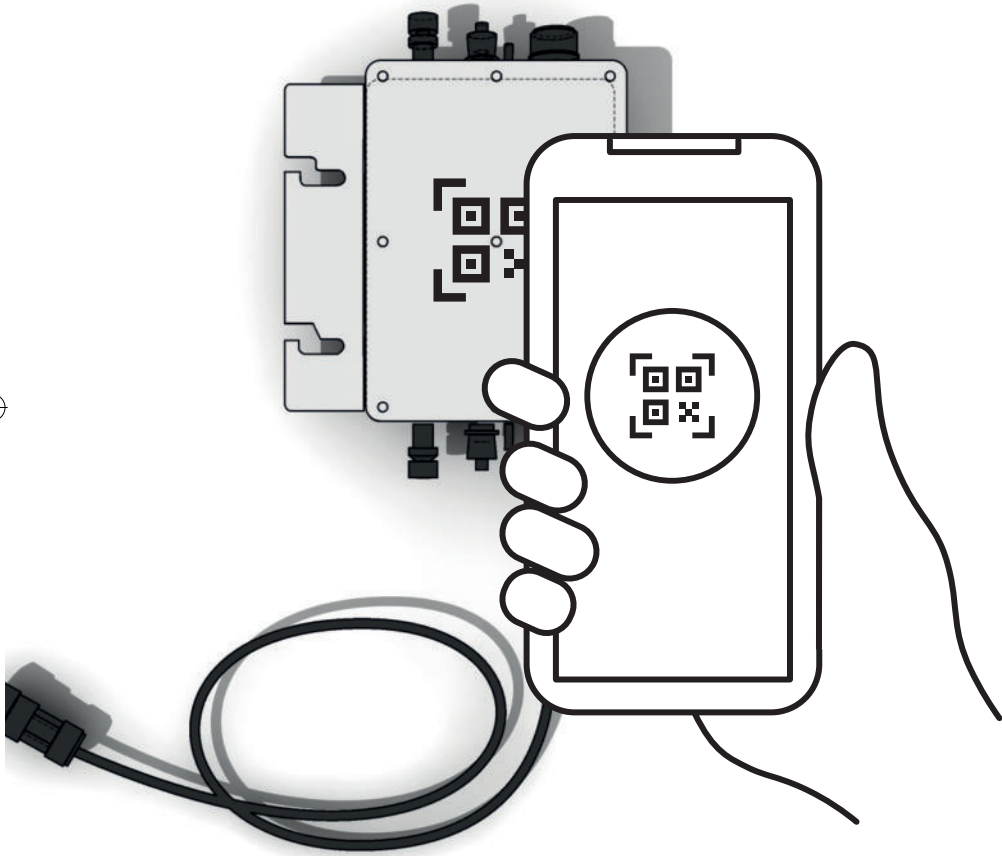



8 HOW TO OPERATE THE INTEGRATED WIFI METER

- Android „Cloud Intelligence“
- Iphone „Cloud Intelligence“

Load the indicated APP
Scan QR-code on the WVC micro-inverter
and follow the instructions





IMPORTANT INFORMATION (EN)

1. Assembly

- a. The np home solar set should be set up on a flat, stable surface, ideally facing in a southerly direction. The casting of shadows onto the surface should be avoided, and there should be unimpeded aeration.
- b. If the np home solar set consists of several units, these must be arranged in such a way that they don't cast shadows on each other.
- c. **To prevent the np home solar set from blowing away in the event of strong winds, you should use a fastening and ballast; we recommend inserting a 30kg weight into the metal basin-shaped element intended for this purpose.**
- d. On a suitable surface the use of additional tent pegs with a minimum length of 30cm is recommended to prevent the device from shifting; appropriately sized anchor screws are recommended as an alternative.
- e. The np home solar set can also be mounted by a licensed roofer onto flat roofs, or using conventional module mounting systems without stands onto suitable slanting roofs (not oriented towards the north).
- f. Attaching the np home solar set onto house walls or balcony borders is possible, but in compliance with a minimum angle of 20° and not oriented to the North. In any case, this form of assembly should be undertaken by a specialist.



2. Connection

- a. The np home solar set should be connected to the electricity grid in such a way that safe and efficient operation is guaranteed in the long term. This should therefore be done by an electrically trained person. **If it is not properly connected, there is a risk to health and property e.g. a short circuit could trigger a fire.**
- b. The np home solar set and connected power supply lines could be damaged or destroyed by the effects of direct or indirect lightning strikes. The likelihood of this depends on the installation site and the existing lightning protection. The np home solar set already contains integrated overvoltage protection that is higher than required by the standard. However, it may still happen that the voltage peaks overburden the available protection and cause some damage. We therefore recommend that the np home solar set is integrated into a comprehensive lightning protector and additional overvoltage protection is installed. If there is existing insurance against lightning damage, you should ensure that the np home solar set is included in this.
- c. **You must check, if the local grid operator must be notified about the connection of the np home solar set to the home grid or must approve this.** For precise reporting of the current flows between the home grid and the local grid, it may be necessary to adapt the existing measuring devices.
- d. Each private electricity grid is sub-divided into different electric circuits, which all have fuses to protect against overloading. These electric circuits are allocated to up to 3 separate „grid phases“. The np home solar set is connected to one of these electric currents via the plug socket, and is therefore also allocated to the grid phase to which this electric current belongs. The electricity generated by the np home solar set is available to all electric circuits within this grid phase. All consumers connected to single-phase private electricity grids can therefore benefit from the solar electricity. If several phases are used, a division of the modules between different grid phases can improve efficiency if an electronic counter separately records the individual grid phases.





- e. **The inverter can provide up to 700 W of power per unit of the NP home solar set, which corresponds to a current of 3.0 amp. Connecting to an outlet is safe under standard conditions.**
- f. Once the cables have been connected as per the user manual, the plug on the energy meter supplied is plugged in, and the meter is then plugged into the suitable plug socket.
- g. The np home solar set only produces electricity if there is a stable alternating current voltage at the plug socket. If there is a failure in the electricity supply from the public grid, or the quality of the public grid exceeds predetermined threshold values (e.g. too large voltage fluctuations, variances in the grid frequency), the electricity production will be automatically stopped and it will not be possible to generate any electricity.
- h. Once the np home solar set has been connected to a plug socket, a test is initially carried out to determine whether there is a stable voltage. The supply of electricity will only start once this test has been positively completed and there is sufficient solar electricity available. If the plug of the np home solar set is taken out of the plug socket, it takes a few split seconds until the delivery of solar electricity is disrupted. Touching the plug contacts of the np home solar set without a connection to the home grid is generally not dangerous.
- i. The cable of the np home solar set may not be screwed down or damaged. They must be used as carefully as other power cables in the household.
- j. If water does however seep into the plug connection and there is a short circuit, the electricity supply will be immediately cut off and the np home solar set will not release any more electricity.

3. Operation

- a. During operation the glass surfaces of the np home solar set must be kept free from pollutants.
- b. During the winter months, snow or ice should be immediately removed from the surface of the module, as otherwise no electricity will be generated.
- c. Ensure that there are not technical defects that could impair the generation of electricity. In no case should you repair any defects yourself, but should instead contact your supplier or our service department.
- d. The np home solar set only generate electricity in daylight. This should be taken into account when consuming electricity.
- e. You can monitor electricity generation using the integrated particular App.
- f. **Before the power cord is unscrewed from the inverter, it is imperative to pull out the mains plug.**





WICHTIGE HINWEISE (DE)

1. Aufstellung

- a. Das np home solar set ist auf einem ebenen, tragfähigen Untergrund möglichst in südlicher Ausrichtung aufzustellen, eine Beschattung der Oberfläche ist dabei zu vermeiden. Eine ungehinderte Belüftung sollte gegeben sein.
- b. Besteht das np home solar set aus mehreren Einheiten, sind diese so anzuordnen, dass sie sich nicht gegenseitig beschatten.
- c. **Damit das np home solar set nicht bei starkem Wind abhebt, ist für eine Verankerung und Ballast zu sorgen; dazu empfehlen wir jedenfalls in die dafür vorgesehene Blechtasse ein Gewicht von 30 kg einzulegen.**
- d. Es ist bei entsprechendem Untergrund zu empfehlen zusätzlich Heringe mit einer Mindestlänge von 30 cm zu verwenden, um ein Versetzen zu vermeiden; als Alternative sind entsprechend dimensionierte Schraubanker zu empfehlen.
- e. Die np home solar sets können auch von konzessionierten Dachdeckern auf Flachdächern oder mit konventionellen Modulbefestigungssystemen ohne Ständer auf geeigneten Schrägdächern (nicht nach Norden orientiert) befestigt werden.
- f. Das Anbringen an Hauswänden oder Balkoneinfassungen ist auch möglich, dabei sollte aber ein Anstellwinkel von mindestens 20° und eine Vermeidung nördlicher Ausrichtung berücksichtigt werden. Jedenfalls sollte auch eine solche Montage von einem konzessionierten Fachmann durchgeführt werden.



2. Anschluss

- a. Der Anschluss des np home solar sets an das Stromnetz ist so vorzunehmen, dass langfristig ein sicherer und effizienter Betrieb gewährleistet ist. Daher muss sich eine elektrotechnisch ausgebildete Person damit befassen. **Bei unsachgemäßen Anschluss besteht Gefahr für Gesundheit und Sachgüter, da z. B. durch einen Kurzschluss ein Brand ausgelöst werden kann.**
- b. Durch die Auswirkungen eines direkten oder indirekten Blitzschlags können das np solar set und daran angeschlossene Stromleitungen beschädigt oder zerstört werden. Die Wahrscheinlichkeit hängt vom Aufstellungsort bzw. dem vorhandenen Blitzschutz ab. Das np home solar set hat bereits einen integrierten Überspannungsschutz, der höher ist, als es dem Standard entspricht. Es kann jedoch vorkommen, dass in diesem Zusammenhang trotzdem Spannungsspitzen den vorhandenen Schutz überfordern und einen Schaden anrichten. Wir empfehlen daher, dass das np home solar set in einen umfassenden Blitzschutz integriert und ein zusätzlicher Überspannungsschutz installiert wird. Bei einer vorhandenen Versicherung gegen Blitzschäden sollten Sie darauf achten, das np home solar set dort zu integrieren.
- c. **Es ist zu beachten, ob der Anschluss des np home solar sets an das Hausnetz dem örtlichen Netzbetreiber nach Möglichkeit 2 Wochen vor Inbetriebnahme zu melden ist.** Zur exakten Bilanzierung der Stromflüsse zwischen Hausnetz und öffentlichem Netz kann es nötig sein, die bestehenden Messeinrichtungen zu adaptieren.
- d. Jedes private Stromnetz wird in verschiedene Stromkreise gegliedert, die jeweils mit Sicherungen vor einer Überlastung geschützt werden. Diese Stromkreise werden bis zu 3 getrennten „Netzphasen“ zugeordnet. Das np home solar set wird über die Steckdose mit einem dieser Stromkreise verbunden und ist daher auch der zu diesem Stromkreis gehörenden Netzphase zugeordnet. Der im np home solar set erzeugte Strom steht innerhalb dieser Netzphase allen Stromkreisen zur Verfügung. Bei einphasigen privaten Stromnetzen können daher alle dort angeschlossenen Verbraucher vom Solarstrom profitieren.





Bei der Nutzung mehrerer Phasen kann eine Aufteilung der Module auf verschiedene Netzphasen insbesondere dann die Wirtschaftlichkeit verbessern, wenn ein elektronischer Zähler die einzelnen Netzphasen getrennt erfasst.

- e. Je Einheit des np home solar sets kann der Inverter bis zu 700 W bereitstellen, das entspricht einer Stromstärke von rund 1,3 A (Ampere). Ein Anschluss an eine Steckdose ist bei einem normgerechten Stromkreis unbedenklich.**
- f. Nachdem die Kabel entsprechend der Gebrauchsanleitung verbunden wurden, wird der Netzstecker an das mitgelieferte Energiemessgerät angesteckt, das wiederum in die geeignete Steckdose des Hausnetzes eingesteckt wird.
- g. Das np home solar set produziert nur Strom, wenn an der Anschlusssteckdose netzseitig eine stabile Wechselspannung vorhanden ist. Sollte es zu einem Ausfall der Stromversorgung aus dem öffentlichen Netz kommen oder die Qualität des öffentlichen Netzes vorgegebene Grenzwerte überschreiten (z. B. zu große Spannungsschwankungen, Abweichungen der Netzfrequenz), wird die Stromproduktion sofort automatisch unterbrochen bzw. ist keine Stromerzeugung möglich.
- h. Wenn das np home solar set an eine Steckdose angeschlossen wird, erfolgt zunächst eine Prüfung, ob eine stabile Spannung netzseitig vorhanden ist. Erst wenn diese Prüfung positiv verlaufen und ausreichend Solarstrom vorhanden ist, wird mit der Stromeinlieferung begonnen. Wenn der Stecker des np home solar sets aus der Steckdose gezogen wird, dauert es Sekundenbruchteile, bis die Solarstromeinlieferung abgebrochen wird. Damit ist das Berühren der Steckerkontakte des np home solar sets ohne Verbindung zum Hausnetz in der Regel ungefährlich.
- i. Sollte in eine Steckverbindung trotzdem Wasser eindringen und es zu einem Kurzschluss kommen, wird die Stromversorgung sofort unterbrochen und gleichzeitig das np home solar set keinen Strom mehr abgeben.
- j. Die Kabel des np home solar sets dürfen nicht eingeklemmt oder beschädigt werden. Sie sind so sorgsam zu verwenden wie andere Starkstromkabel im Haushalt.

3. Betrieb

- a. Im Betrieb sind die Glasoberflächen der np home solar sets frei von Verunreinigungen zu halten.
- b. In den Wintermonaten sollte Schnee oder Eis von der Moduloberfläche sofort entfernt werden, weil sonst kein Strom erzeugt wird.
- c. Achten Sie darauf, dass es keine technischen Defekte gibt, die die Stromerzeugung beeinträchtigen. Versuchen Sie keinesfalls, bei Defekten selbst Reparaturen vorzunehmen, sondern setzen Sie sich mit Ihrem Lieferanten oder unserem Kundendienst in Verbindung.
- d. Die np home solar sets erzeugen nur bei Tageslicht Strom. Das ist entsprechend beim Stromverbrauch zu berücksichtigen.
- e. Mit den mitgelieferten Energiemessgeräten können Sie die Stromerzeugung überwachen.
- f. Bevor das Netzkabel vom Inverter abgeschraubt wird, ist unbedingt der Netzstecker zu ziehen.**





9 PV POWER SUPPLY...

1. feeds in to the house grid via the plugged connector
2. goes first to all active house facilities
3. goes only to the grid when the total of all house consumers needs less power
4. in 3-phase-system is also credited to the other two-phases („meter balance“)

... or simply charge the battery of your E-bike!

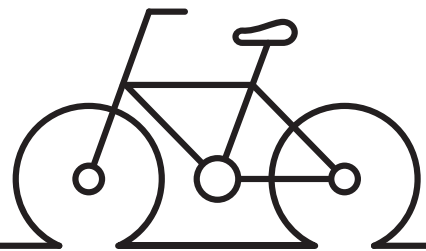
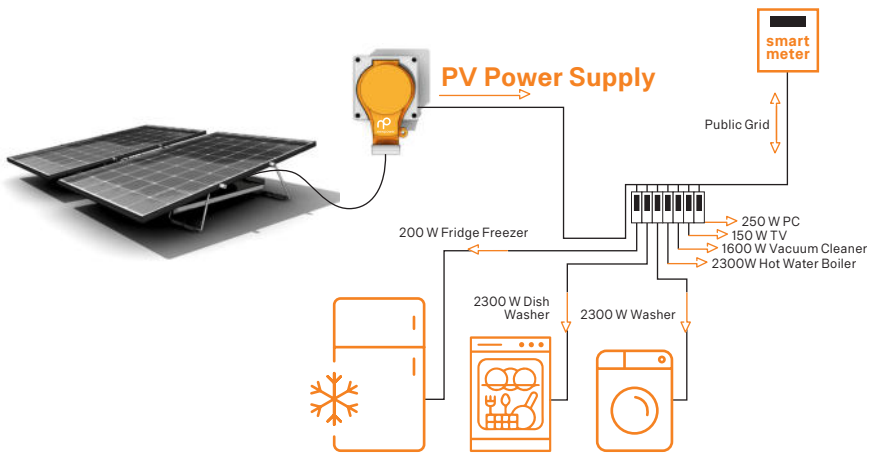



HOW IT WORKS



10 GREATER PV-PLANTS

- ✓ There is no limit to put the double sets in parallel
- ✓ You only need the NP SOLAR KIT „double extension“
- ✓ Ask your electric installer





11 THE MAIN FEATURE OF THE NP HOME SOLAR SET

- Plug-in ready
- PV-module + inverter + rack + power cord + connectors + meter
- Easy handling (no special tools required)
- Rack can be folded
- Top quality components
- Mono PERC modules (highest performance)
- Top economics
- 5 years product warranty
- Registered EU Community Design
- Communication wireless WIFI
- WIFI-meter
- TUEV tested „ready for use“
- PV -modules up to 4,99W plus sorting/up to 5600Pa mech.load
- All components are CE certified





FEATURES



NP HOME SOLAR SET	NP SS DOUBLE
PV-MODULE	
Number of cells	2 x 60
Nominal Power (W-p)	minimum 2 x 300
Cell Design	Mono Perc
Cells Efficiency	minimum 23 %
Module Efficiency	minimum 19,5%
Max Wind Load	2600 Pa
Max Mech Load	5600 Pa
Product Warranty	12 years
Special Features	Sand, Salt, NH3, PID resistant, 0 till +4,99 W plus sorting
Performance	30 years linear - 80,7 % end output
Frame Height 40 mm	
INVERTER	
Inverter Type	WVC 700 W
Rated Output	680 W
Power Factor	> 0,95
MPPT-Efficiency (dynamic)	99,3 %
EN 505030 efficiency (EU)	95,7 %
Ambient Temp. Range	-40 till +65 ° C
Communication	WiFi
RACK	
Supports	10 mm Galvanized Steel Wire
PV-Module Inclination	15°
Ballast (ground anchor recom.)	30-45 kg (Max. wind speed 130 km/h) per unit
OTHER FEATURES	
Electric Cable Material	H05RN-F 3G1,00
Grid Connection Cable Length	5 m
Power Meter	W, kWh, T
Standards	according to CE declaration





newpower

New Power Energy AG

Brünigstraße 114

CH-6060 Sarne

T +41 41 508 7070

office@np-energy.com

np-energy.com

